

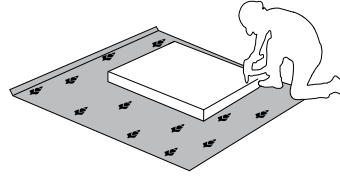

VAŽNO – PRE UPOTREBE PAŽLJIVO PROČITAJTE I SAČUVAJTE UPUTSTVO
IMPORTANT – READ CAREFULLY – RETAIN FOR FUTURE REFERENCE
WICHTIG – SORGFÄLTIG LESEN UND AUFBEWAHREN
ВАЖНО – ПРОЧИТЕ ВНИМАТЕЛЬНО – СОХРАНИТЬ ДЛЯ ДАЛЬНЕЙШЕГО ИСПОЛЬЗОВАНИЯ
WAŻNE – PRZED UŻYCIEM NALEŻY DOKŁADNIE ZAPOZNAĆ SIĘ Z NINIEJSZĄ INSTRUKCJĄ I ZACHOWAĆ JĄ

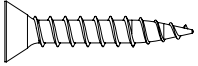

P1-AR
LWH - 468x555x2236
08.02.2023

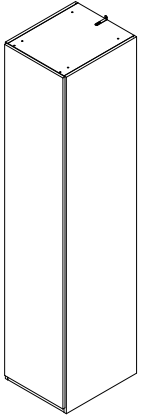
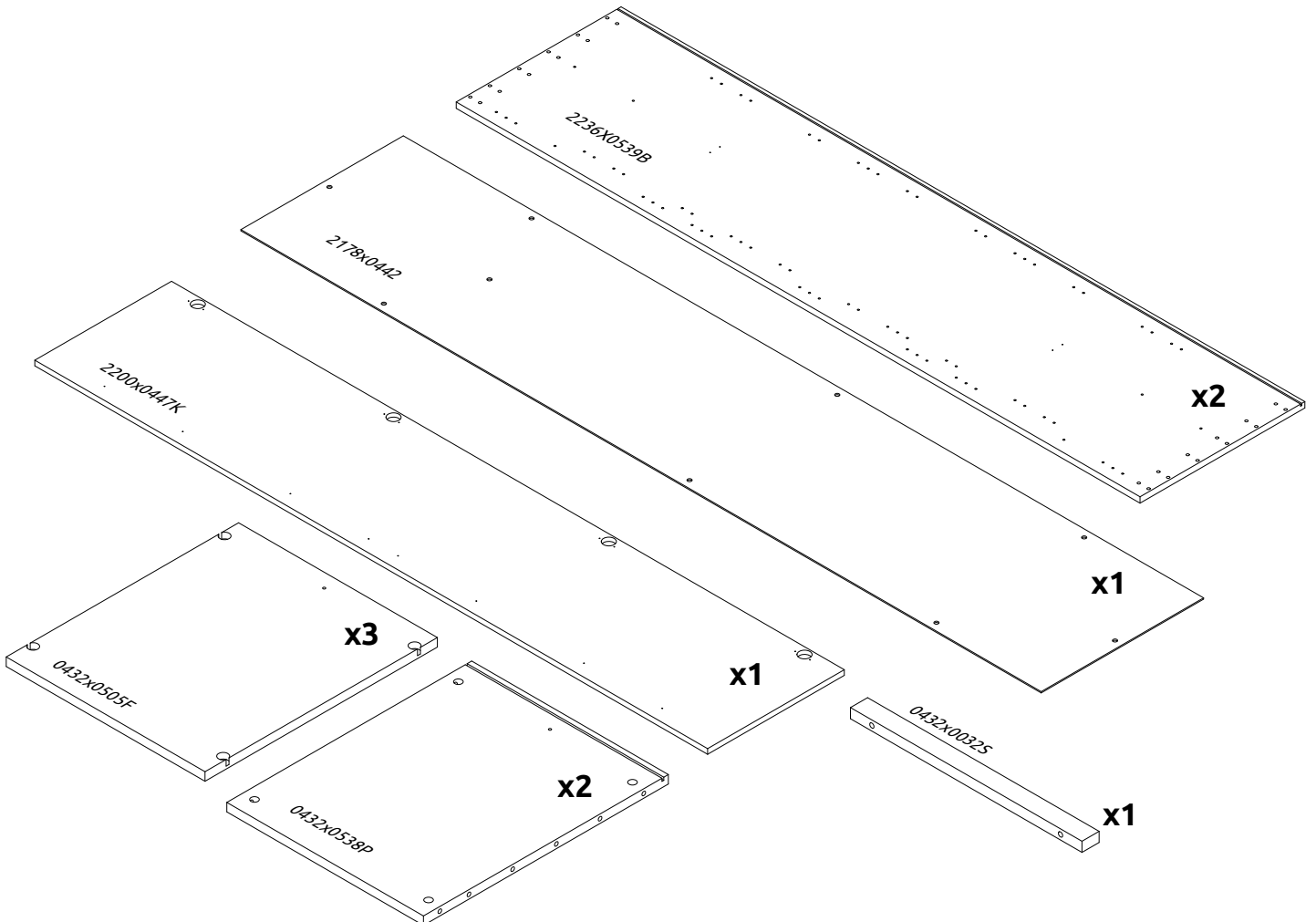
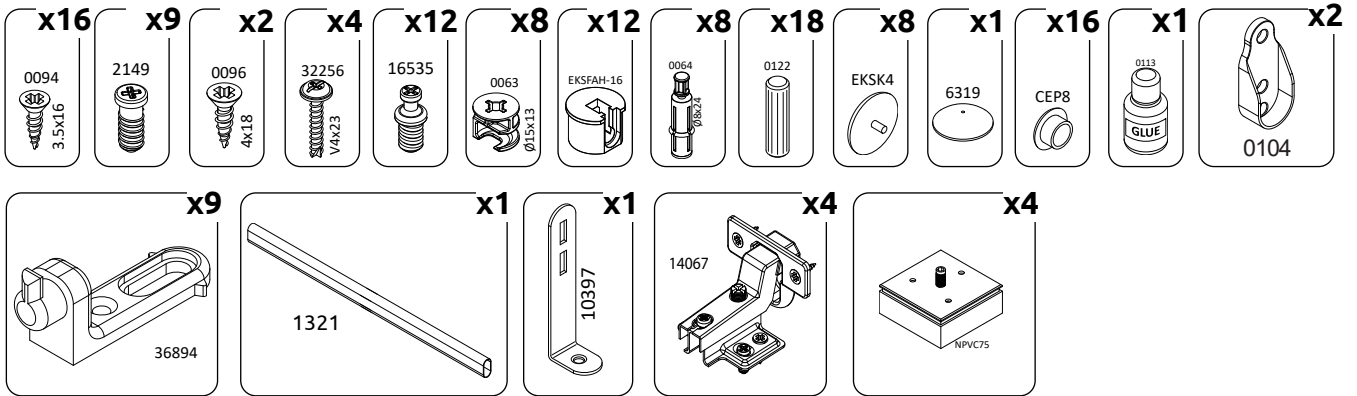

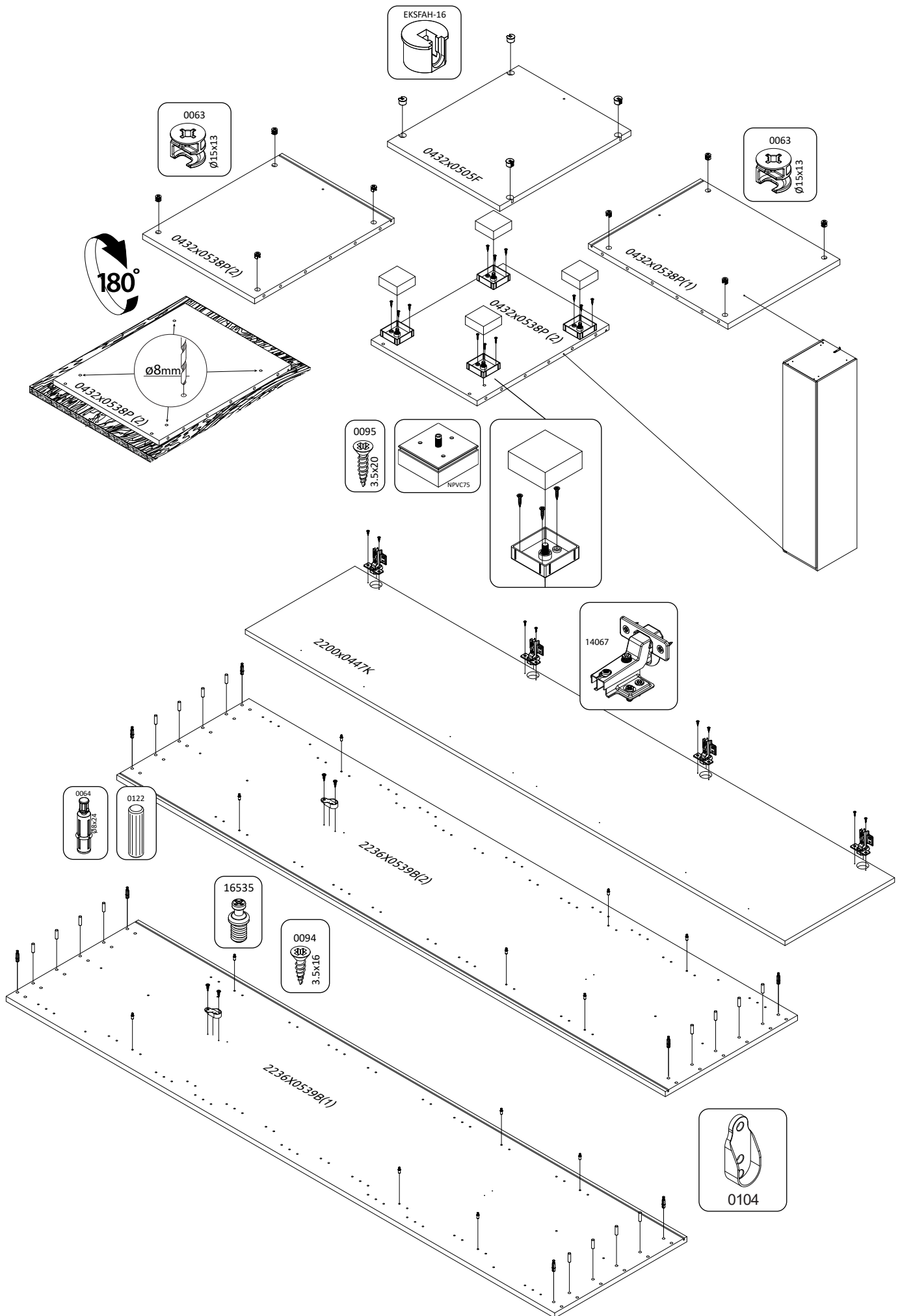

1

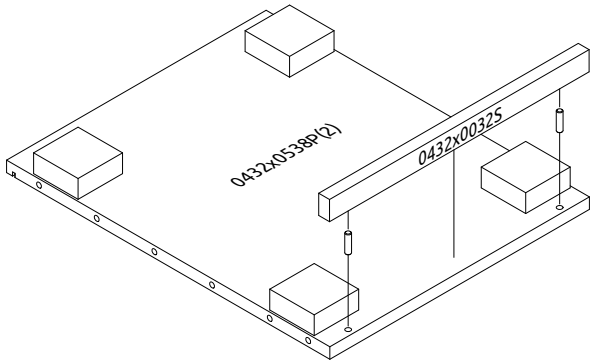
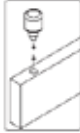
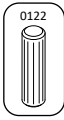

2

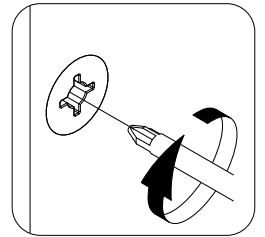
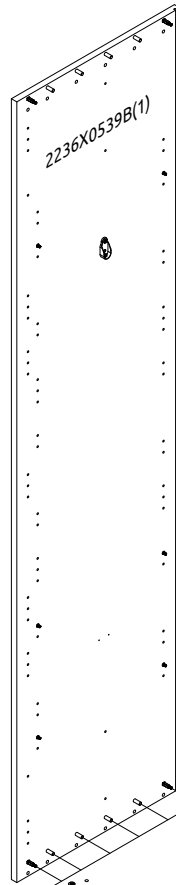

3

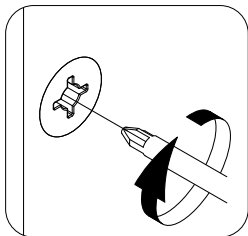
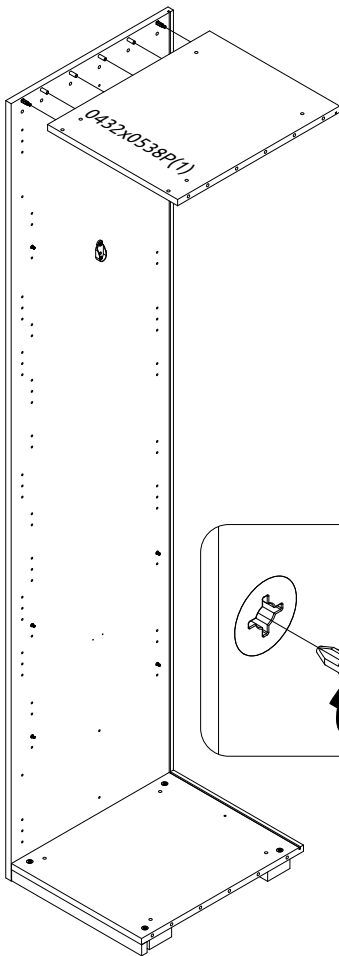

4

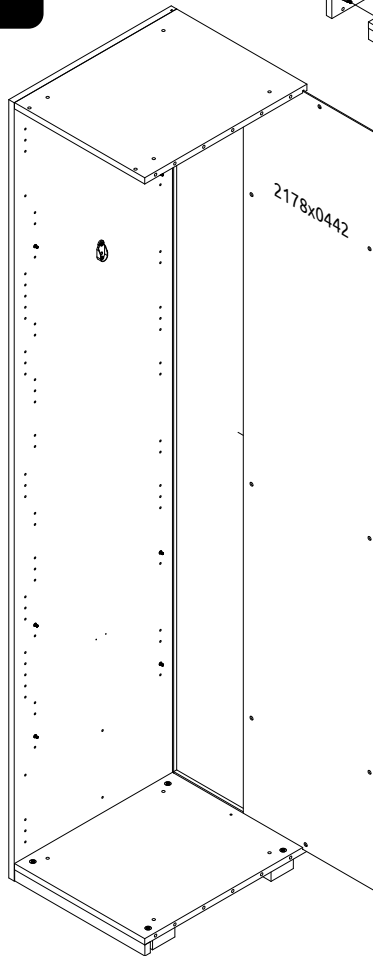

5



*opt 1

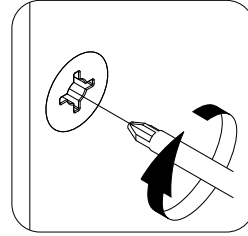
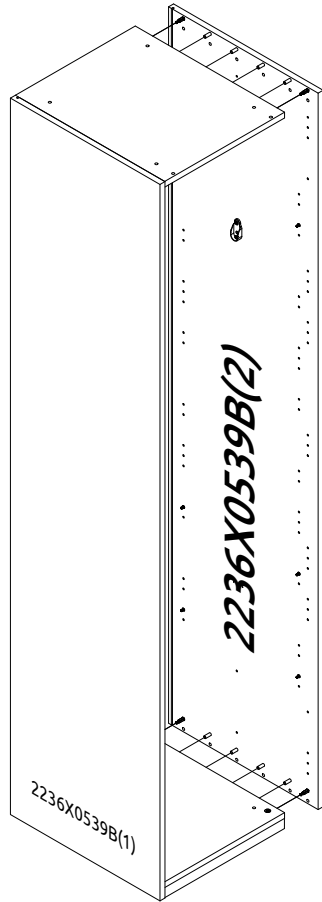

*opt 2

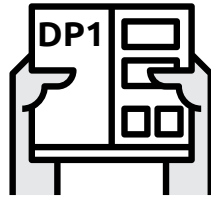
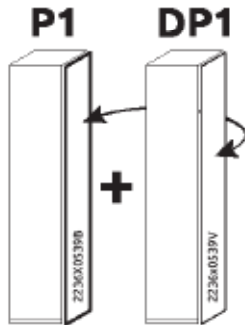

*opt 3

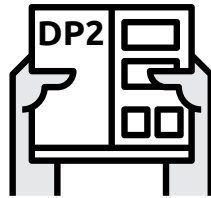
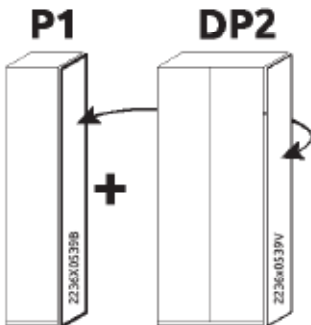

*opt 4

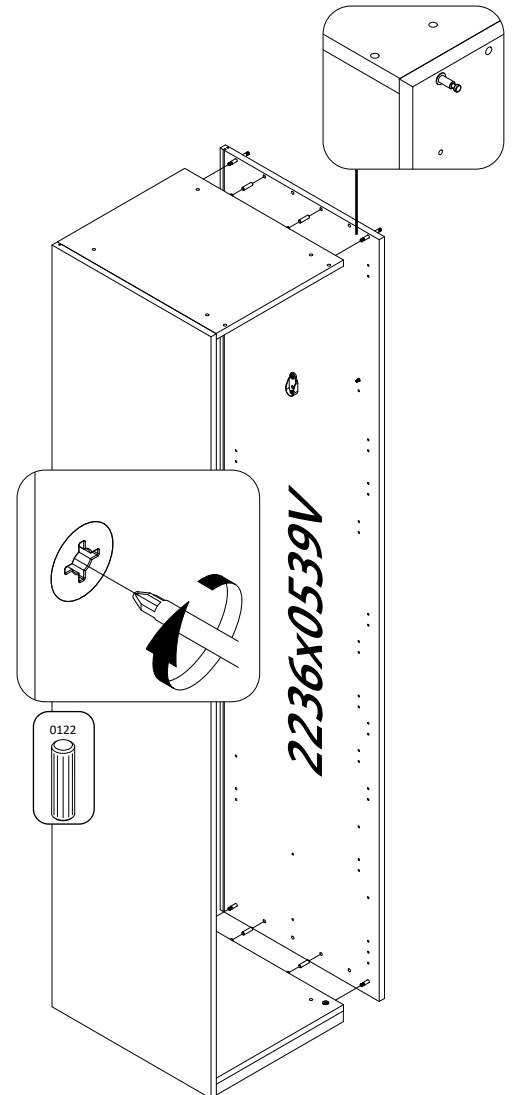
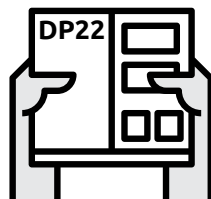
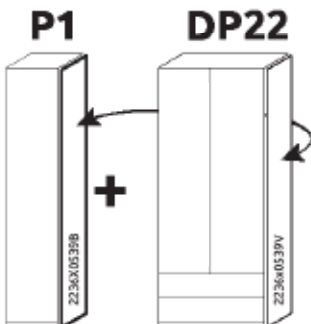

6

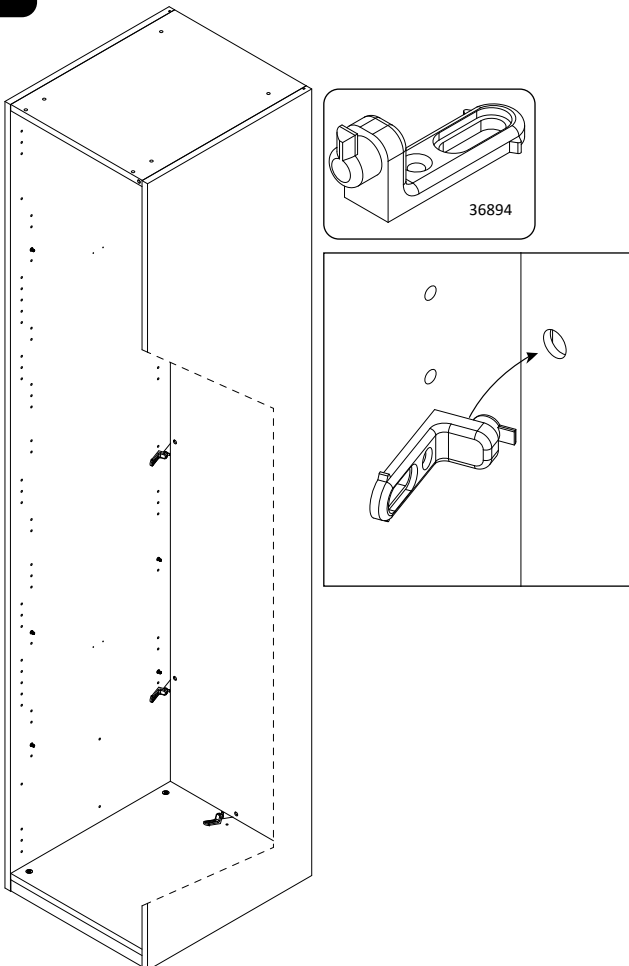

7

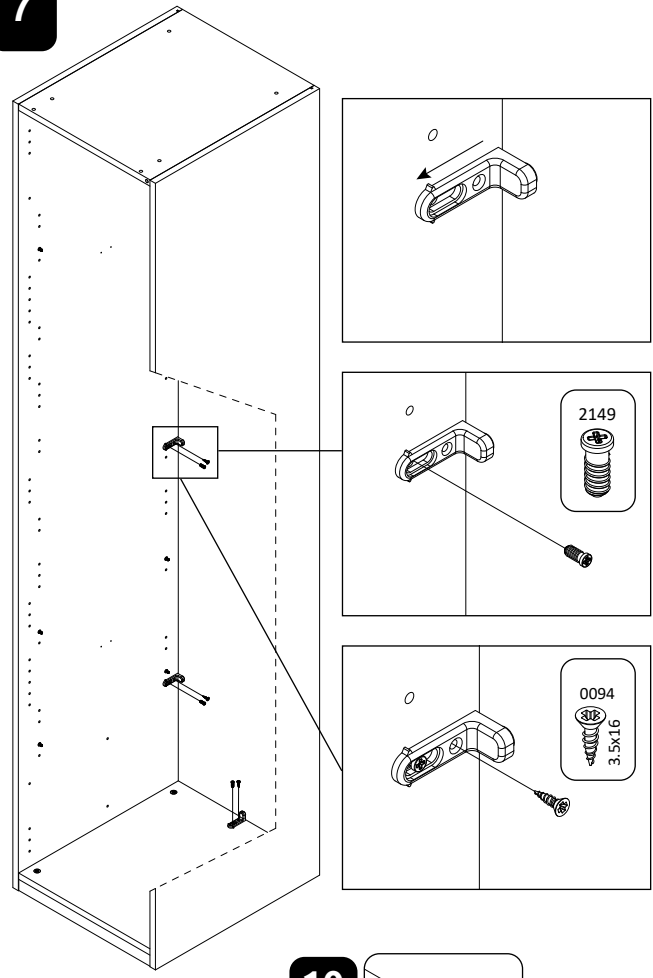

8

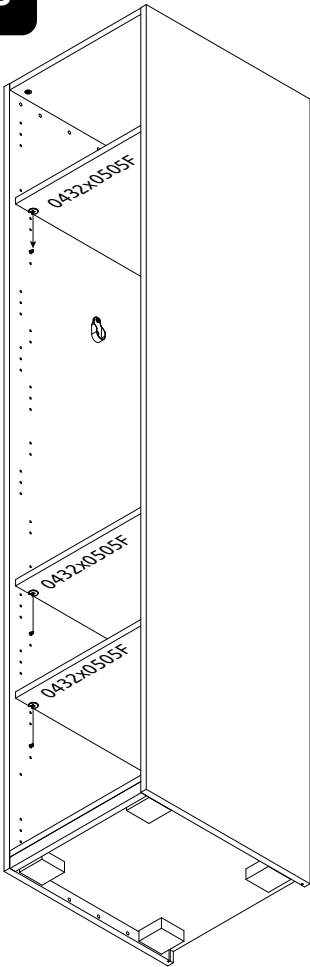

9

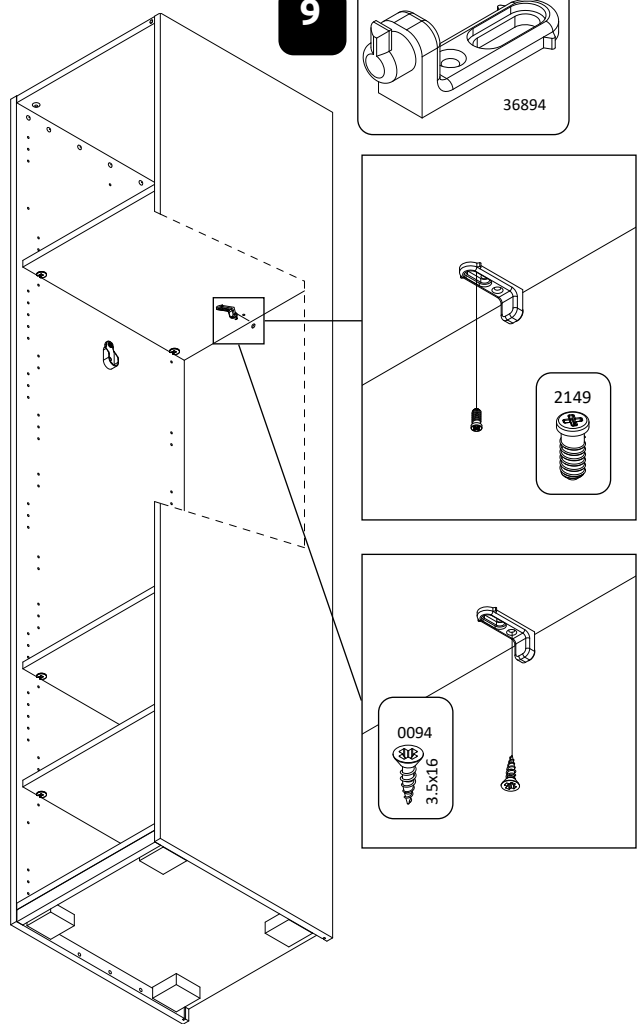

10

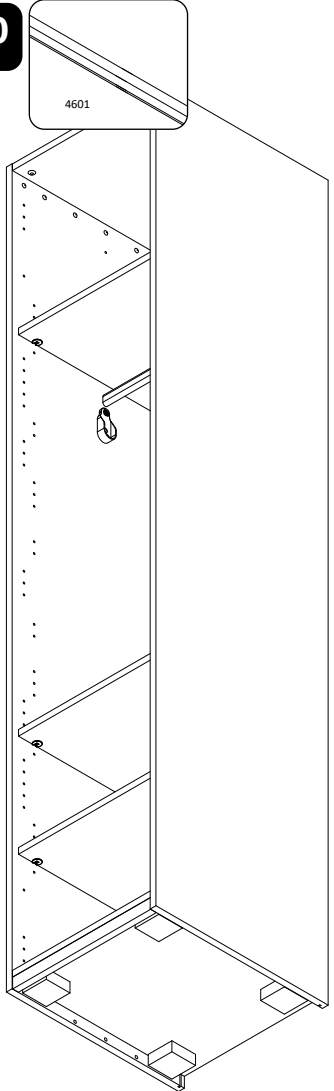

11

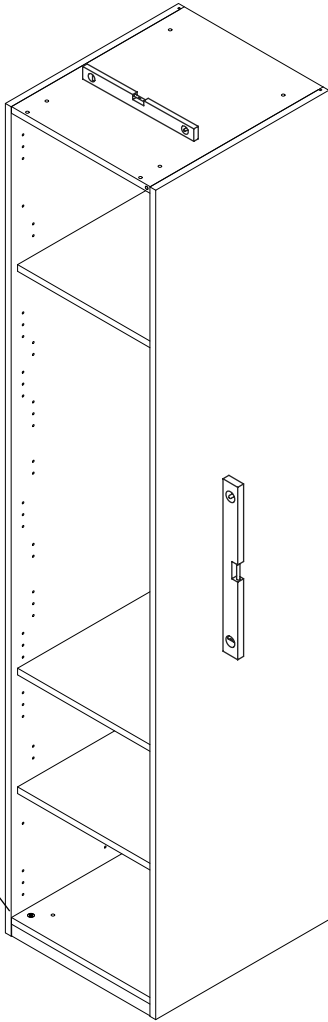
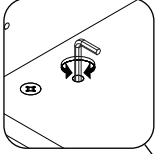
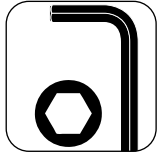
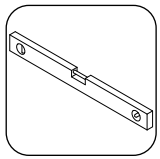

12

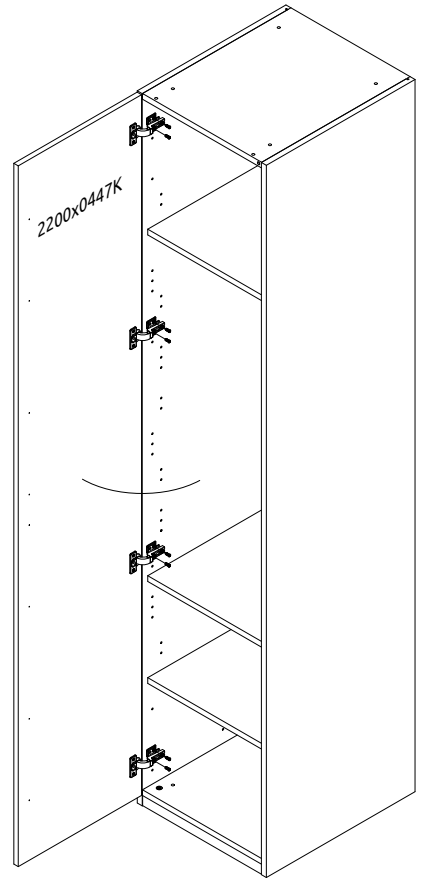
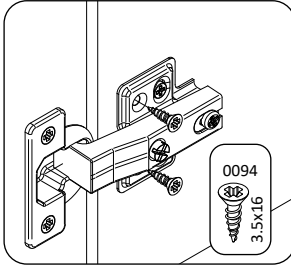
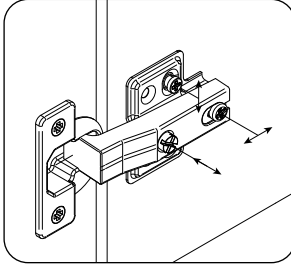
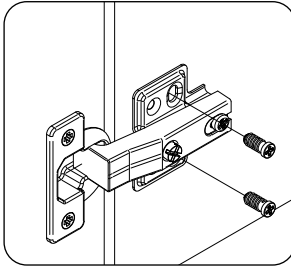

13

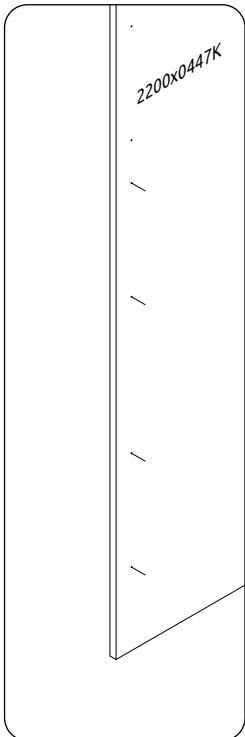

14

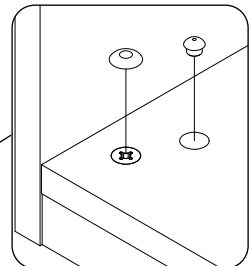
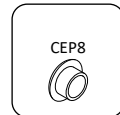
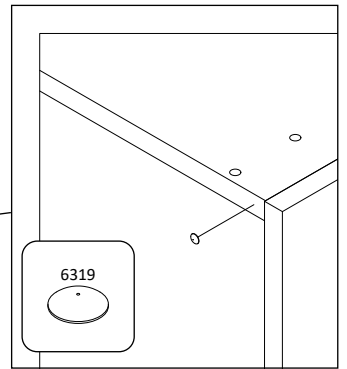
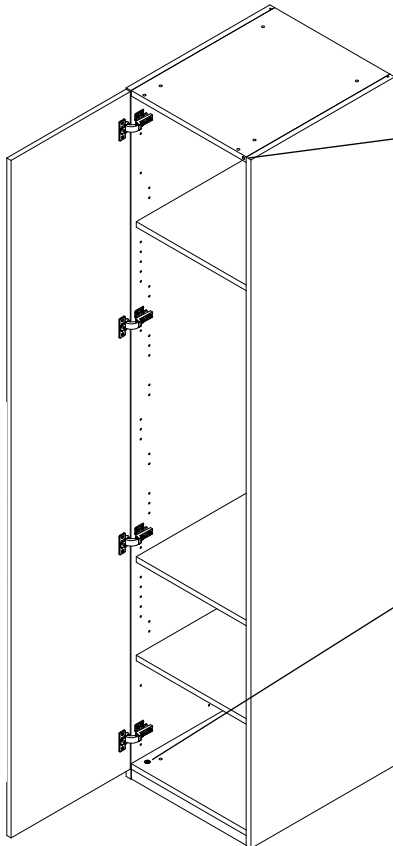

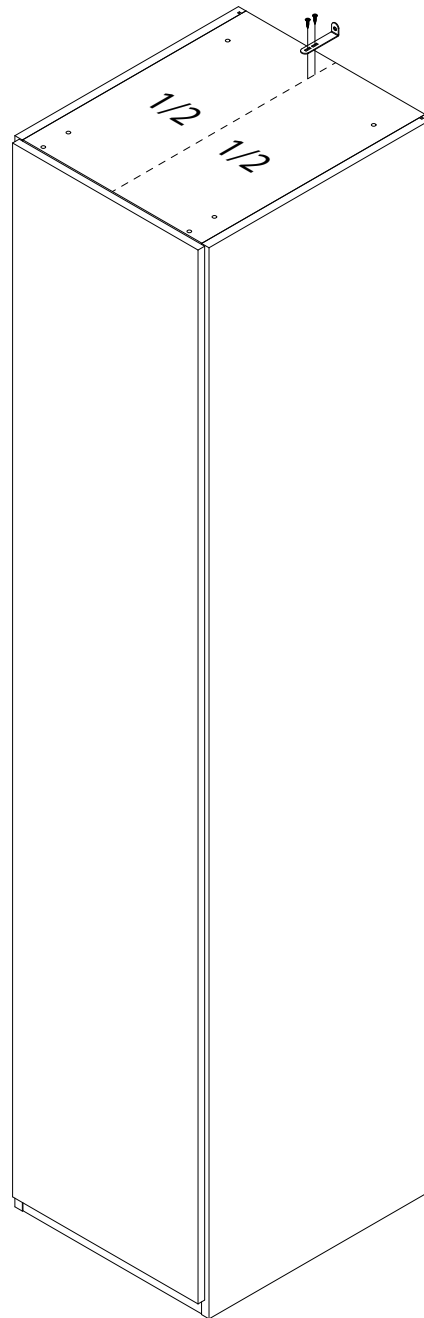
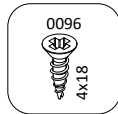
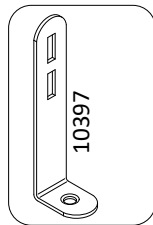
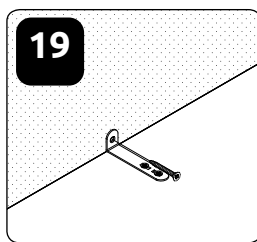
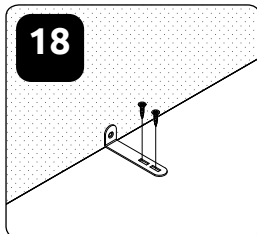
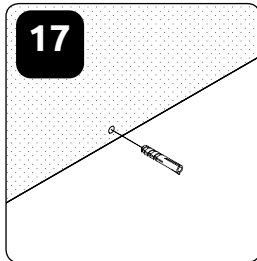
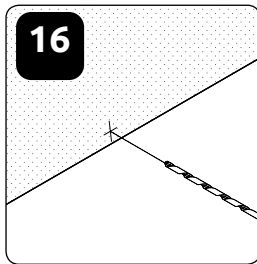
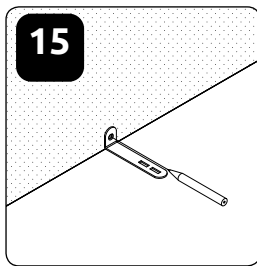

РУССКИЙ

Важная информация.
Внимательно прочитайте.
Сохраните эту информацию.

ВНИМАНИЕ

Крепежные средства для крепления к стене не прилагаются, для разных материалов стен требуются различные крепления. Используйте крепежные средства, подходящие для материала стен в Вашем доме. Если Вы не уверены, какой тип крепления подходит к данному материалу, обратитесь в специализированный магазин.

SRPSKI

Bitno!
Pažljivo pročitajte!
Sačuvajte za ubuduće.

UPOZORENJE!

Nisu dati okovi, tiplovi i šrafovi za pričvršćivanje jer se zidovi razlikuju i različiti materijali zahtevaju i različite okove. Upotrebite one koji su pogodni za zidove u vašem domu. Za savet koje okove da upotrebite, obratite se u lokalnoj gvozdari.

ENGLISH

Important information
Read carefully.
Keep this information for further reference.

WARNING!

Fixing devices for the wall are not included since different wall materials require different types of fixing devices. Use fixing devices suitable for the walls in your home. For advice on suitable fixing systems, contact your local specialized dealer.

DEUTSCH

Wichtige Information Bitte sorgfältig lesen und aufbewahren!

ACHTUNG HINWEIS!

Beschläge für die Wandbefestigung sind nicht beigelegt, da sie von der jeweiligen Wandbeschaffenheit abhängig sind. Benutzen Sie ausschließlich Befestigungsbeschläge, die für die heimischen Wände geeignet sind. Bei diesbezüglichen Fragen ziehen Sie den örtlichen Fachhandel zu Rate.

POLSKI

Ważne!
Uważnie przeczytać!
Zachować do wykorzystania w przyszłości.

OSTRZEŻENIE!

Elementy do mocowania w ścianie: kotwy i wkręty do nich, nie zostały dostarczone w opakowaniu ponieważ ściany są wykonane z różnych materiałów, które wymagają różnych elementów montażowych. Prosimy zakupić i zastosować te, które są odpowiednie do ścian w Państwa mieszkaniu. Aby uzyskać poradę, jakie elementy mocujące zastosować, należy skontaktować się ze sprzedawcami w wyspecjalizowanym sklepie.

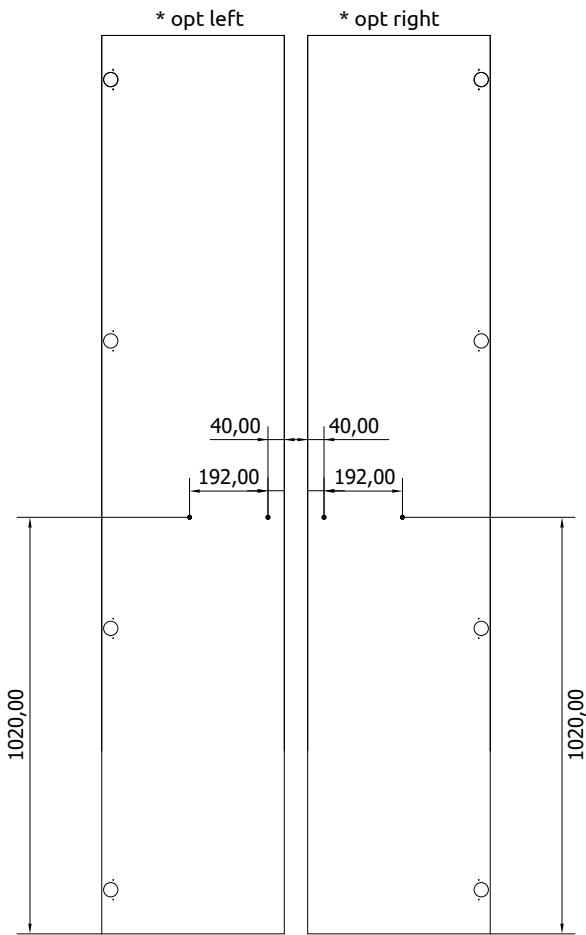

*** OPT**

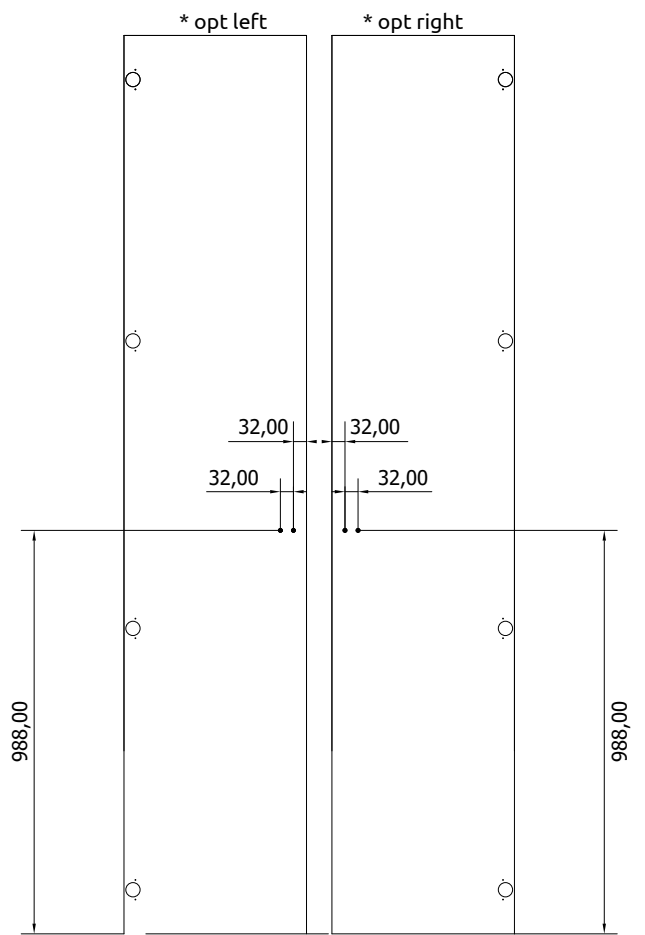
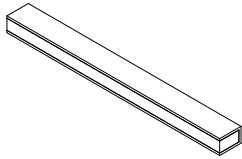

*** OPT**

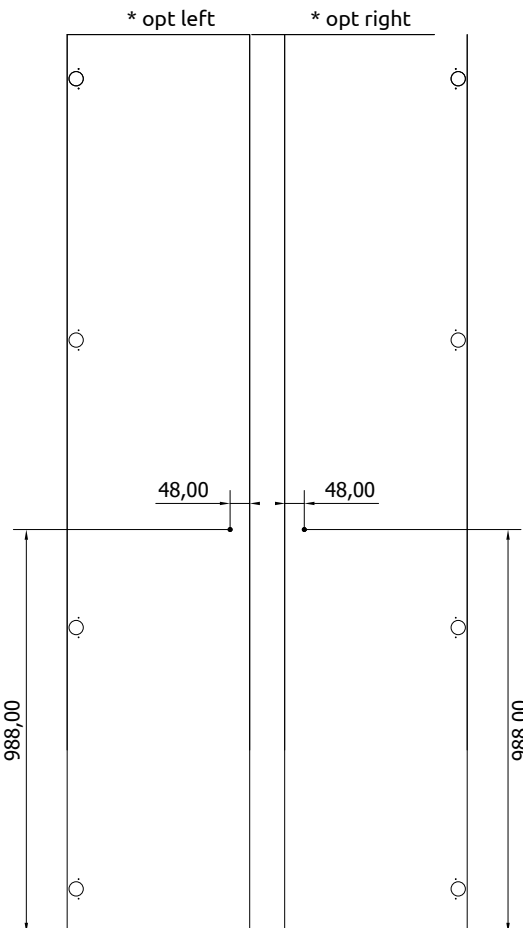
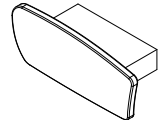

*** OPT**

